

Varenummer: 2302003112
Beskrivelse: E+G Høj Fingermetrik
B.259/25 B-M8

Mål

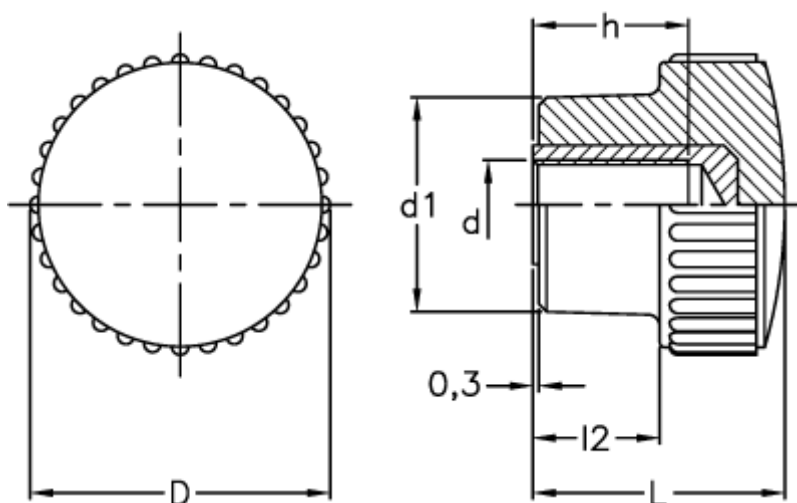

D	= 26
d1	= 16
d 6H	= M8
h	= 20
L	= 28
l2	= 15